

Magneto-resistive Sensor ICs

Standard Power Series: SM351RT, SM451R, SM353RT, SM453R

32309592

Issue B

Datasheet

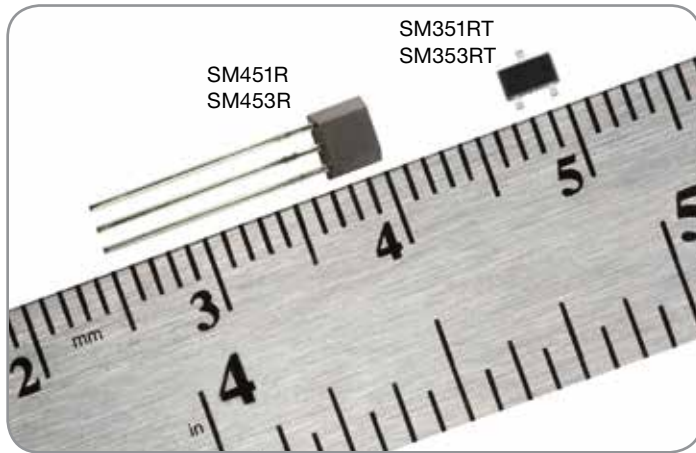

DESCRIPTION

Honeywell's Magneto-resistive Sensor ICs (integrated circuits), Standard Power Series, are ultra-sensitive devices designed for manufacturers who need a durable and reliable speed or position sensor for large air gaps or small magnetic fields in standard power (typically 3 Vdc to 24 Vdc) applications. Unlike reed switches and other magnetic sensors, Honeywell's solid state design offers ultra-high sensitivity of 11 G max., making it the highest sensitivity sensor in its class for standard powered applications. The Magneto-resistive Sensor ICs, Standard Power Series, respond to either a North or South pole applied in a direction parallel to the sensor. They do not require the magnet polarity to be identified, simplifying installation and potentially reducing system cost.

VALUE TO CUSTOMERS

- Durable and reliable due to magnetic solid state, non-contact, no-glass design which enhance switching capability.
- Cost-effective and flexible due to the sensor IC's ultra-high sensitivity—the highest sensitivity sensor in its class for standard powered applications—which lowers the customer's cost of magnets and simplifies design-in.
- Simplifies design-in for wired applications due to its supply voltage range, omnipolar operation, SOT-23 and flat TO-92-style package options and wide operating temperature range.

DIFFERENTIATION

- Ultra-high sensitivity (SM351RT and SM451R) allows for potential use in applications requiring ultra-high magnetic sensitivity (7 G typical operate, 11 G maximum operate).

FEATURES

- Magnetic sensitivities:
 - Ultra-high sensitivity (SM351RT and SM451R): For applications requiring ultra-high magnetic sensitivity (7 G typical operate, 11 G maximum operate)
 - Very high sensitivity (SM353RT and SM453R): For applications requiring very high magnetic sensitivity (14 G typical operate, 20 G maximum operate)
- Package styles:
 - SOT-23 (SM351RT, SM353RT)
 - Flat TO-92-style (SM451R, SM453R)
- Supply voltage range 3 Vdc to 24 Vdc
- Omnipolar sensing activates with either pole from a magnet
- Temperature range -40 °C to 85 °C [-40 °F to 185 °F]
- SOT-23 supplied on tape and reel (3000 units per reel)
- RoHS-compliant materials meet Directive 2002/95/EC

POTENTIAL APPLICATIONS

Industrial

- High frequency flow sensing in HVAC, water, fuel meters, and gas utility meters
- Anti-tamper detection in water, electric, and gas utility meters
- Liquid level detection
- Motor RPM sensing
- In-cylinder position sensing

Medical

- RPM sensing in exercise and rehabilitation equipment
- Magnetic interrupt in exercise and rehabilitation equipment
- Absence/presence detection in infusion pumps
- Position sensing of medication dispensing cabinet drawers
- Incline position sensing in hospital beds

White Goods

- Lid, door and drawer position detection
- Fluid flow detection
- Liquid level detection

PORTFOLIO

Honeywell's Standard Power Series join:

- Magneto-resistive sensor ICs, including the [Nanopower Series](#), [2SS52M Series](#), [SS552MT Series](#)
- Hall-effect sensor ICs, including the [SS351A](#), [SS451A](#)

Magnetoresistive Sensor ICs

Standard Power Series: SM351RT, SM451R, SM353RT, SM453R

Table 1. Electrical Specifications (3 V < Vcc < 24 V, -40 °C < Ta < 85 °C [-40 °F < Ta < 185 °F] unless otherwise specified.)

Characteristic	Condition	Min.	Typ.	Max.	Unit
Supply voltage (Vcc)	Vcc reference to ground	3	12	24	V
Supply current:	—			8	
off	Vcc = 5 V, T = 25 °C [77 °F]	—	2.5	3.5	mA
on	Vcc = 5 V, T = 25 °C [77 °F]	—	4	5	
Start-up time	Vcc > 3 V	—	—	10	µs
Output leakage current	Vcc = 24, off	—	—	10	µA
Output saturation voltage	load current = 20 mA	—	—	500	mV
Rise time	Vcc = 5 V, R = 2 kOhm, C = 20 pF	—	—	1.5	
Fall time	Vcc = 5 V, R = 2 kOhm, C = 20 pF	—	—	1.5	µs

Table 2. Magnetic Specifications (3 V < Vcc < 24 V, -40 °C < Ta < 85 °C [-40 °F < Ta < 185 °F].)

Characteristic	Min.	Typ.	Max.	Unit
SM351RT, SM451R:				
operate (positive)	3	7	11	Gauss
release (positive)	2	4.8	9	
differential	—	2.2	—	
SM353RT, SM453R:				
operate (positive)	6	14	20	Gauss
release (positive)	3	9.3	18	
differential	—	5.7	—	

NOTICE

The magnetic field strength (Gauss) required to cause the switch to change state (operate and release) will be as specified in the magnetic characteristics. To test the switch against the specified magnetic characteristics, the switch must be placed in a uniform magnetic field.

NOTICE

These magnetoresistive sensor ICs may have an initial output in either the ON or OFF state if powered up with an applied magnetic field in the differential zone (applied magnetic field >Brp and <Bop). Honeywell recommends allowing 10 µs for output voltage to stabilize after supply voltage has reached its final rated value.

Table 3. Absolute Maximum Ratings

Characteristic	Condition	Min.	Typ.	Max.	Unit
Operating temperature	ambient	-40 [-40]	—	85 [185]	°C [°F]
Soldering temperature:					
SM351RT, SM353RT	ambient applied for < 10 s	—	—	245 [473]	°C [°F]
SM451R, SM453R	ambient applied for < 3 s	—	—	260 [500]	
Supply voltage (Vs)	—	-26	—	26	V
Load current	output sinking (open collector)	—	—	40	µA

NOTICE

Absolute maximum ratings are the extreme limits that the device will withstand without damage to the device. However, the electrical and mechanical characteristics are not guaranteed as the maximum limits (above recommended operating conditions) are approached, nor will the device necessarily operate at absolute maximum ratings.



Magnetostrictive Sensor ICs

Standard Power Series: SM351RT, SM451R, SM353RT, SM453R

Figure 1. Typical Magnetic Performance versus Temperature

SM351RT, SM451R

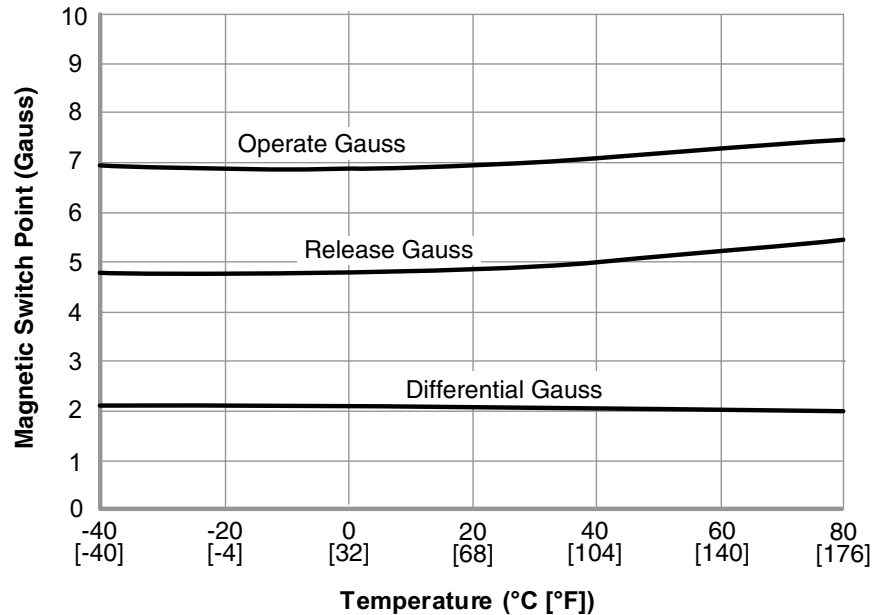

SM353RT, SM453R

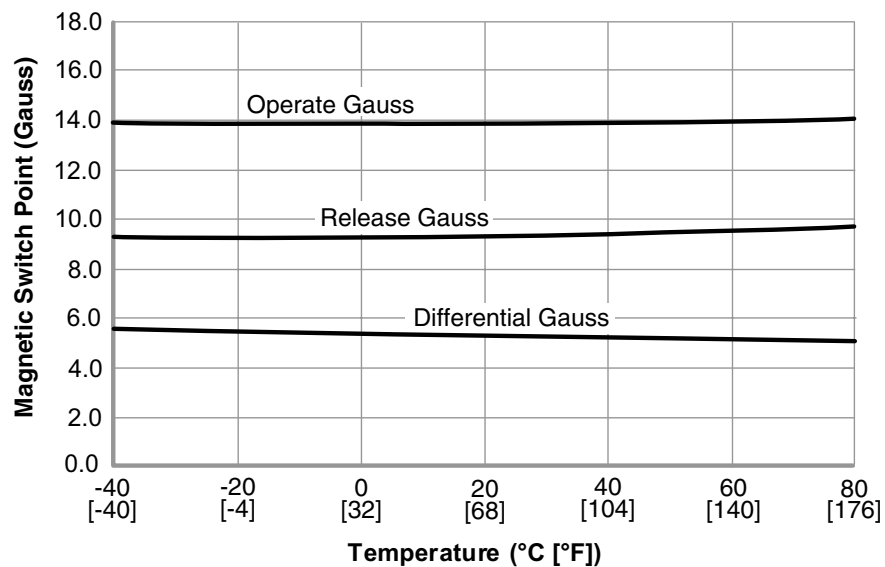
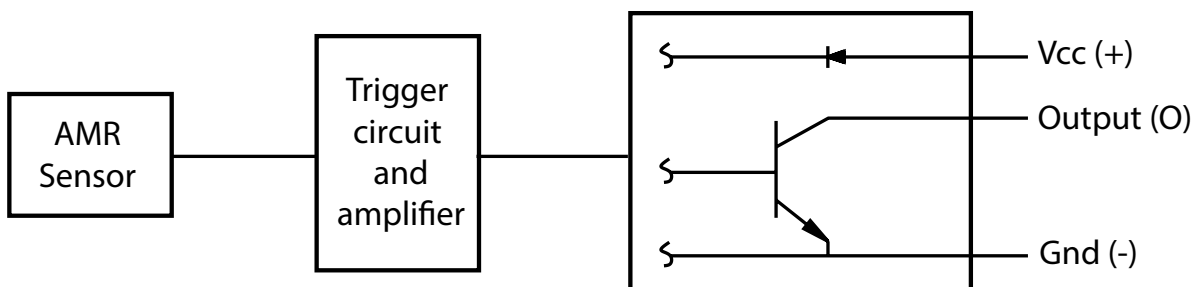

Figure 2. Block/Electrical Diagram



Magneto-resistive Sensor ICs

Standard Power Series: SM351RT, SM451R, SM353RT, SM453R

Figure 3. Alignment of the Magnet to the SOT-23 Package (SM351RT, SM353RT) Omnipolar Magneto-resistive Sensor IC

Ideal alignment: The magnet is aligned in the same plane as the sensor IC.

The magnetic flux lines stay horizontal as the magnet approaches the sensor IC (see Figure 3.A).

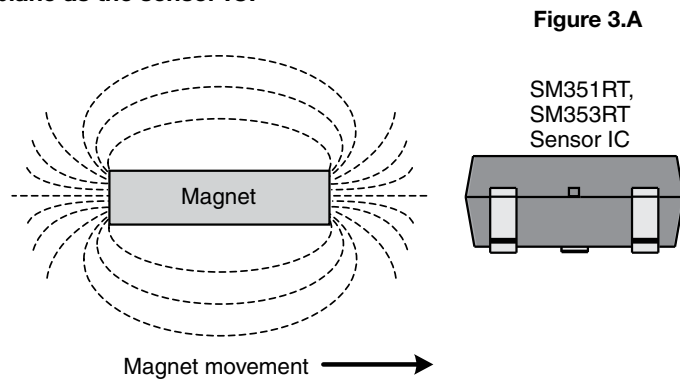

Offset alignment: The magnet is not aligned in the same plane as the sensor IC.

Parallel magnet approach to the sensor IC may cause dead zones.

Dead zones may occur when the majority of the magnet's magnetic flux lines become vertical as it approaches the sensor IC, turning the sensor IC ON, then OFF, then ON (see Figure 3.B).

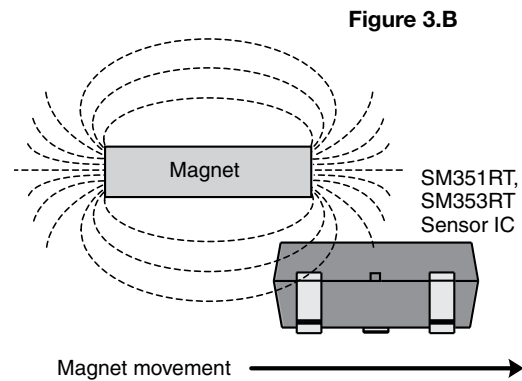

Perpendicular magnet approach to the sensor IC eliminates possible dead zones.

The sensor IC detects the approaching magnet's horizontal magnetic flux lines, turning the sensor IC to ON. The sensor IC stays ON as the magnet continues to approach. When the magnet is located directly over the sensor IC, all magnetic flux lines are now horizontal (see Figure 3.C). (Note: This alignment decreases the magnetic flux strength at the sensor IC.)

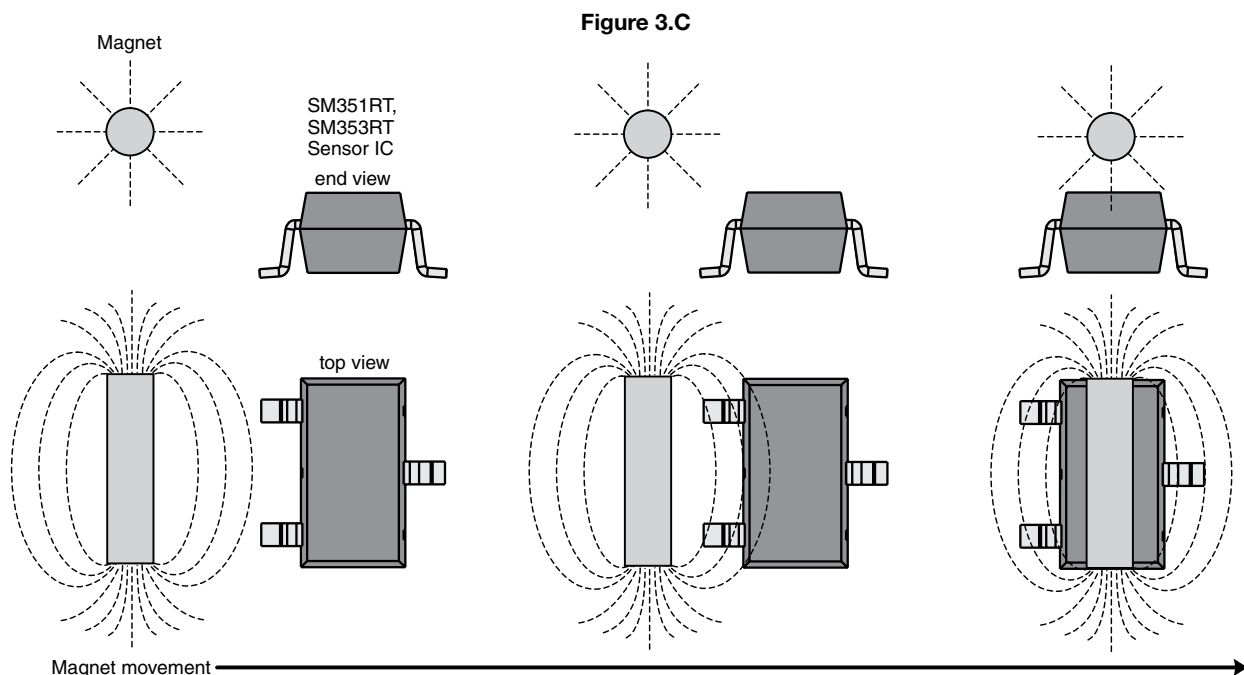

Magneto-resistive Sensor ICs

Standard Power Series: SM351RT, SM451R, SM353RT, SM453R

Figure 4. Alignment of the Magnet to the TO-92-Style Package (SM451R, SM453R) Omnipolar Magneto-resistive Sensor IC

Ideal alignment: The magnet is aligned in the same plane as the sensor IC.

The magnetic flux lines stay horizontal as the magnet approaches the sensor IC (see Figure 4.A).

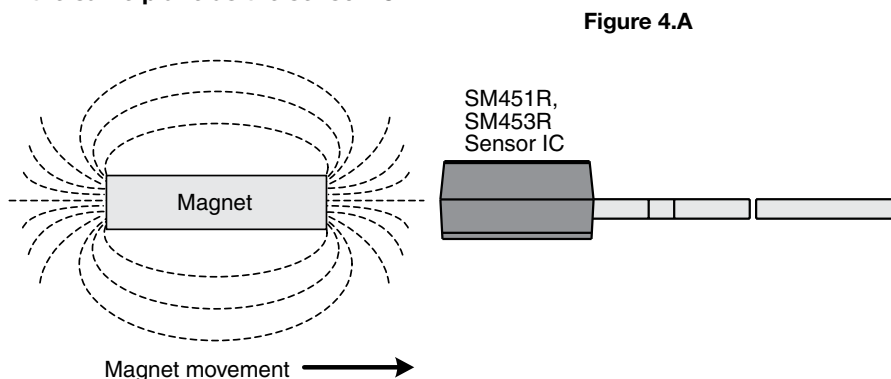

Offset alignment: The magnet is not aligned in the same plane as the sensor IC.

Parallel magnet approach to the sensor IC may cause dead zones.

Dead zones may occur when the majority of the magnet's magnetic flux lines become vertical as it approaches the sensor IC, turning the sensor IC ON, then OFF, then ON (see Figure 4.B).

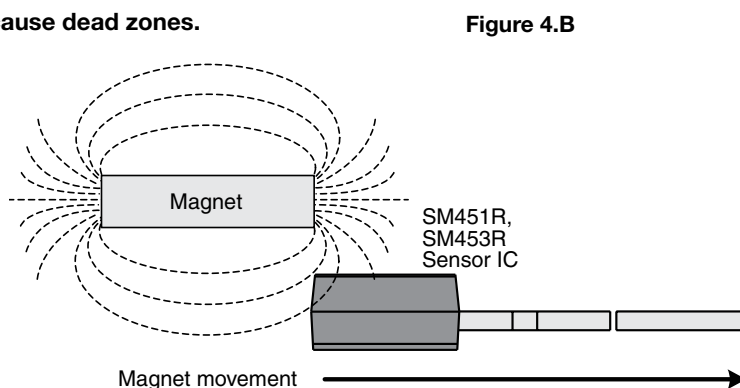

Perpendicular magnet approach to the sensor IC eliminates possible dead zones.

The sensor IC detects the approaching magnet's horizontal magnetic flux lines, turning the sensor IC to ON. The sensor IC stays ON as the magnet continues to approach. When the magnet is located directly over the sensor IC, all magnetic flux lines are now horizontal (see Figure 4.C). (Note: This alignment decreases the magnetic flux strength at the sensor IC.)

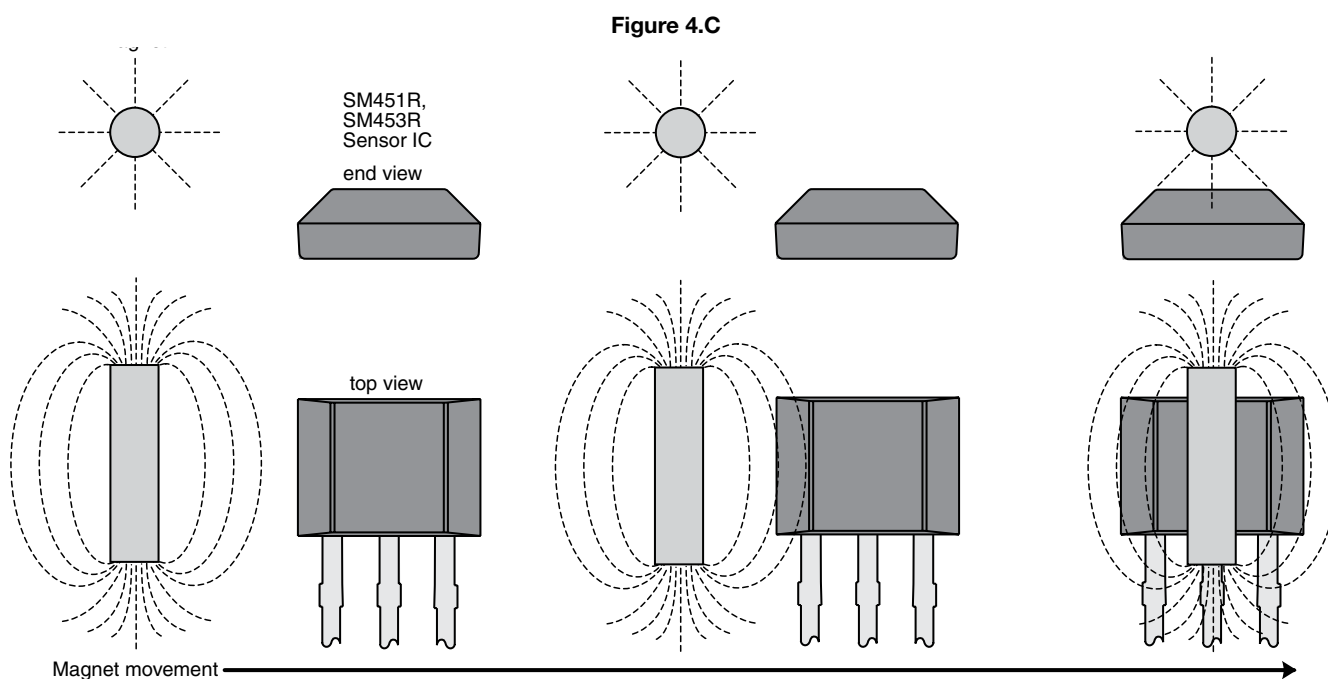

Magnetoresistive Sensor ICs

Standard Power Series: SM351RT, SM451R, SM353RT, SM453R

Figure 6. SM451R and SM453R Mounting Dimensions (For reference only. mm/[in].)

Sensor

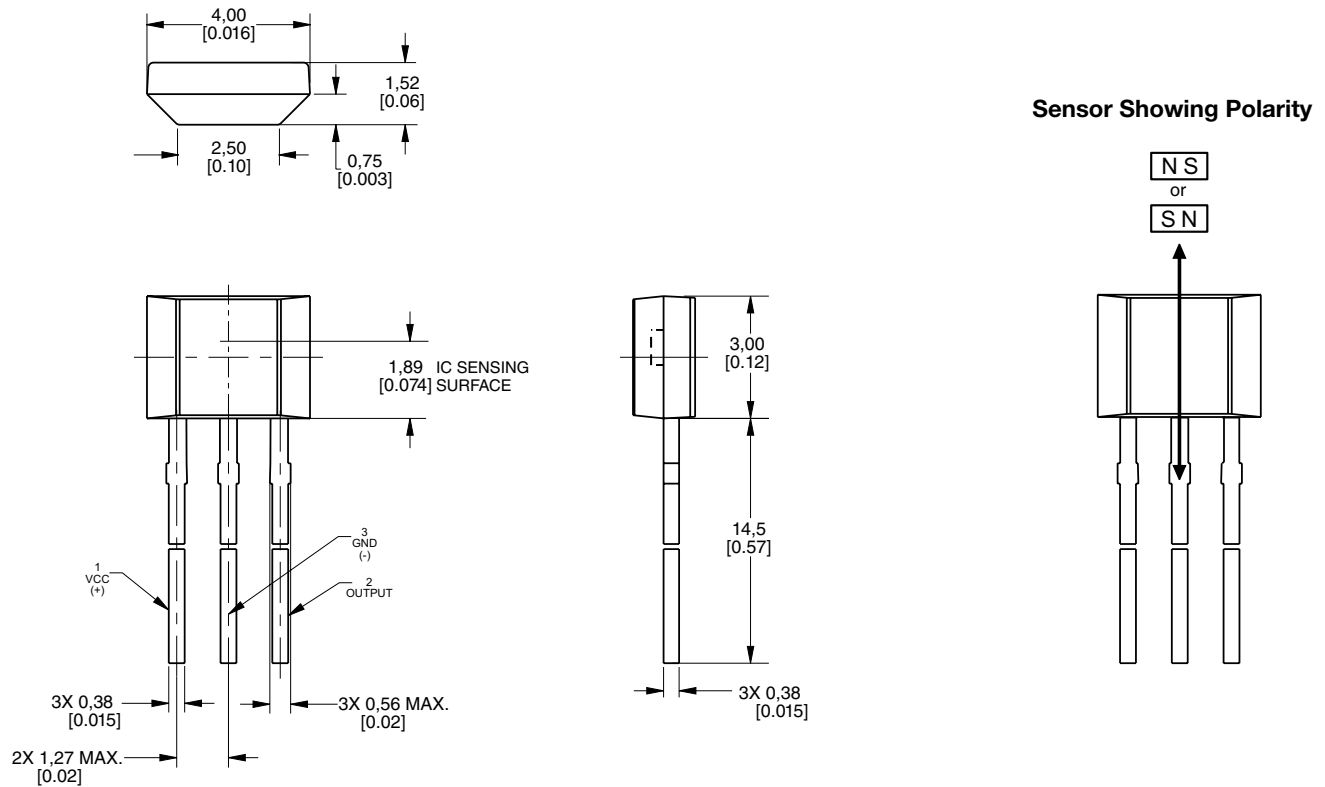



Table 4. Order Guide

Catalog Listing	Description	
SM351RT	Magnetoresistive sensor IC, ultra-high sensitivity (7 G typ.), standard power, SOT-23 package, pocket tape and reel packaging (3000 units per reel)	
SM353RT	Magnetoresistive sensor IC, very high sensitivity (14 G typ.), standard power, SOT-23 package, pocket tape and reel packaging (3000 units per reel)	
SM451R	Magnetoresistive sensor IC, ultra-high sensitivity (7 G typ.), standard power, flat TO-92-style package, bulk packaging (1000 units per bag)	
SM453R	Magnetoresistive sensor IC, very high sensitivity (14 G typ.), standard power, flat TO-92-style package, bulk packaging (1000 units per bag)	

ADDITIONAL INFORMATION

The following associated literature is available on the Honeywell web site at sensing.honeywell.com:

- Product Installation Instructions
- Product Application Note
- Magnetic Sensors Line Guide
- Position Sensors Range guide
- Magnetic Sensors Selection Chart
- Magnetic Sensors Line Card

Find out more

Honeywell serves its customers through a worldwide network of sales offices, representatives and distributors.

For application assistance, current specifications, pricing or name of the nearest Authorized Distributor, contact your local sales office.

To learn more about Honeywell Sensing and Productivity Solutions' products, call **+1-815-235-6847** or **1-800-537-6945**, visit **sensing.honeywell.com**, or e-mail inquiries to **info.sc@honeywell.com**

Sensing and Productivity Solutions
Honeywell
1985 Douglas Drive North
Golden Valley, MN 55422
honeywell.com

⚠ WARNING **PERSONAL INJURY**

DO NOT USE these products as safety or emergency stop devices or in any other application where failure of the product could result in personal injury.

Failure to comply with these instructions could result in death or serious injury.

⚠ WARNING **MISUSE OF DOCUMENTATION**

- The information presented in this datasheet is for reference only. Do not use this document as a product installation guide.
- Complete installation, operation, and maintenance information is provided in the instructions supplied with each product.

Failure to comply with these instructions could result in death or serious injury.

Warranty/Remedy

Honeywell warrants goods of its manufacture as being free of defective materials and faulty workmanship. Honeywell's standard product warranty applies unless agreed to otherwise by Honeywell in writing; please refer to your order acknowledgement or consult your local sales office for specific warranty details. If warranted goods are returned to Honeywell during the period of coverage, Honeywell will repair or replace, at its option, without charge those items it finds defective.

The foregoing is buyer's sole remedy and is in lieu of all other warranties, expressed or implied, including those of merchantability and fitness for a particular purpose. In no event shall Honeywell be liable for consequential, special, or indirect damages.

While we provide application assistance personally, through our literature and the Honeywell web site, it is up to the customer to determine the suitability of the product in the application.

Specifications may change without notice. The information we supply is believed to be accurate and reliable as of this printing. However, we assume no responsibility for its use.

Honeywell